

The Pneumatic Conveying Company

THEREC ENGINEERING & CONSULTING CO.,LTD.

THEREC PROCESSING MACHINE CO.,LTD



Company Profile

Since the year 1996, more than 20 years being the pioneer in building the pneumatics conveying system , including with producing and importing of the equipment in the relating field.

Today THEREC is stepping forward to be the leader in this specific method of bulk material handling process line ,more than 140 systems and more than 1,500 jobs of sale , service and installation of the related equipment is the very good prove for our skill ,experiences , responsibility and the reputation of our company in the industry.

Starting from the beginning of the year 2013, to be 100% concentrate in providing the consulting and designing for the pneumatic conveying system and powder & bulk material handling process, our project department has been separated to be the new company **“Therec Engineering & Consulting Co., Ltd.”**

With the high experience and knowledge of our strong engineering design team and the full support from other company in the group, together with the highest continuous attempt, we are now ready to provide the full engineering design and consulting service in the field of pneumatic conveying and bulk material handling system.

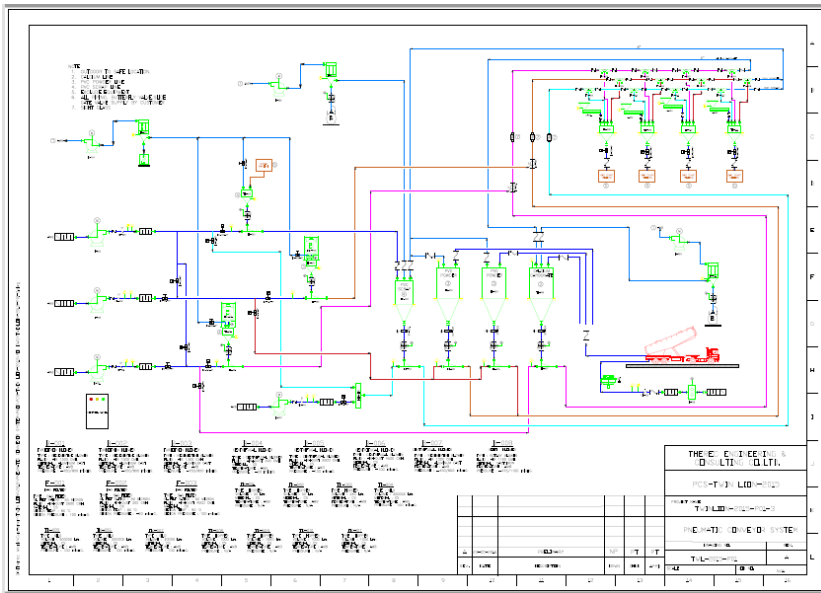

Pneumatic conveying system

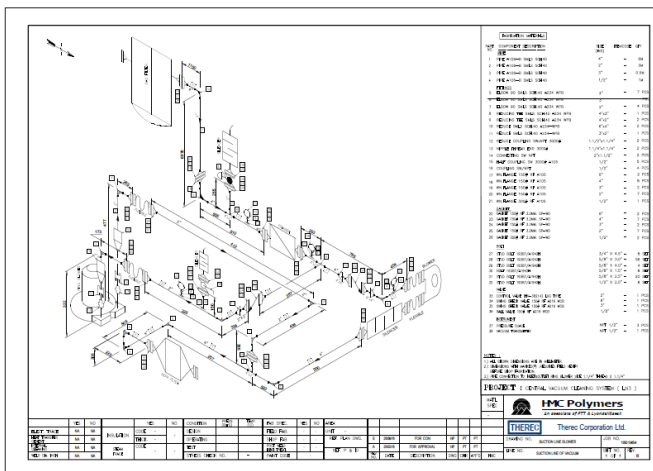

Central Vacuum cleaning system

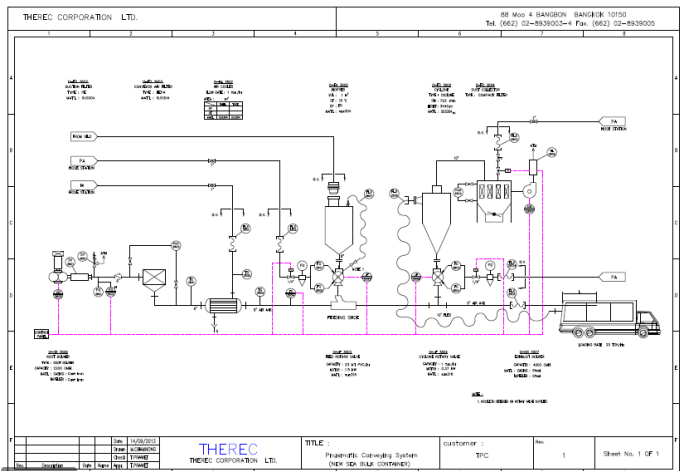

Sea Bulk loading system

Company References

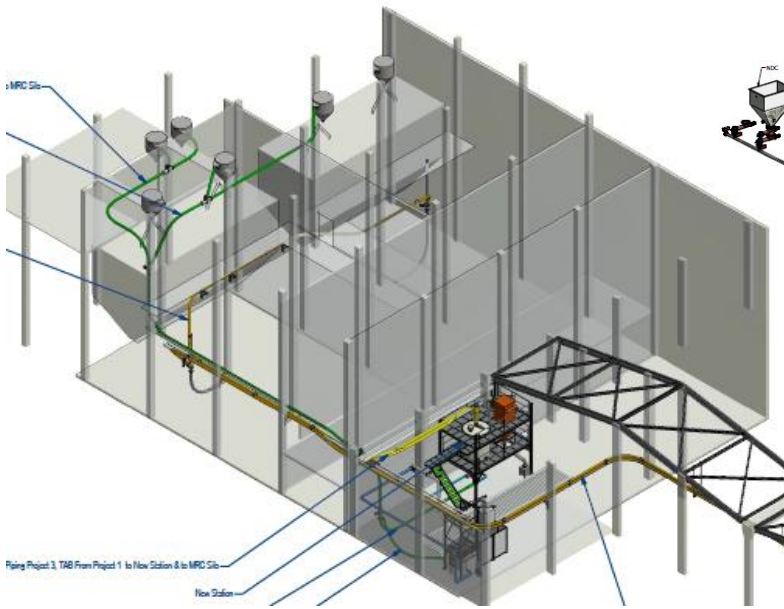

Quality Coffee Co., Ltd. / Nest Cafe

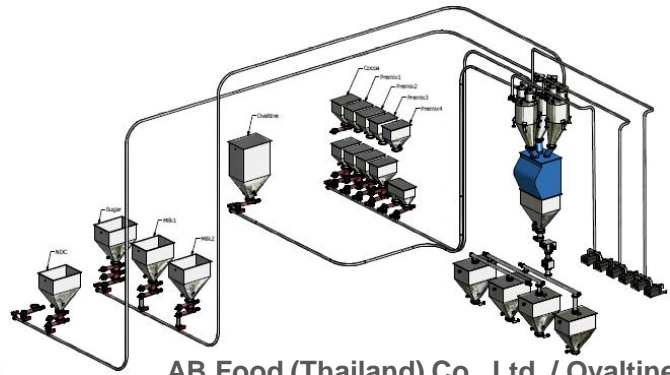

AB Food (Thailand) Co., Ltd. / Ovaltine

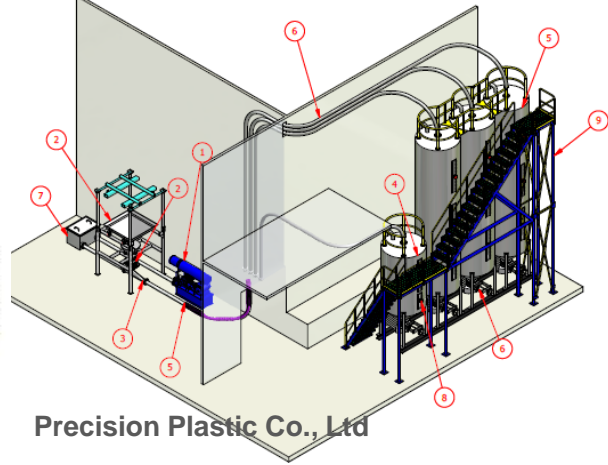

Precision Plastic Co., Ltd

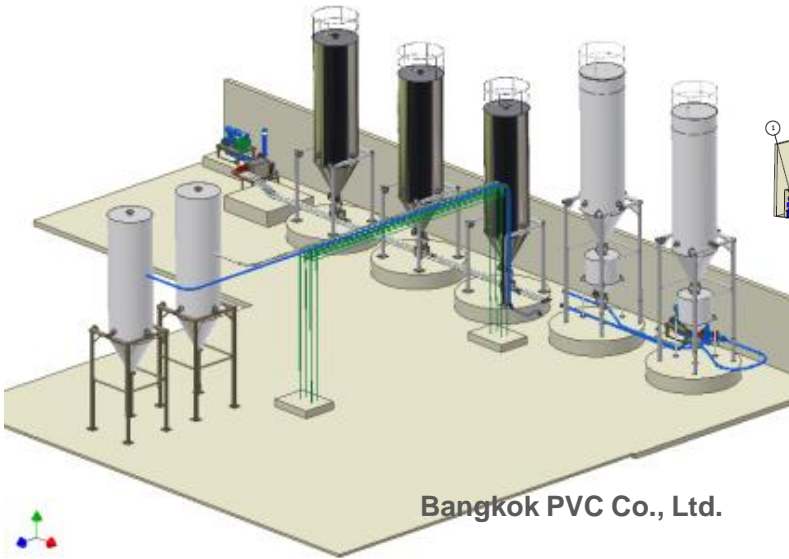

Bangkok PVC Co., Ltd.

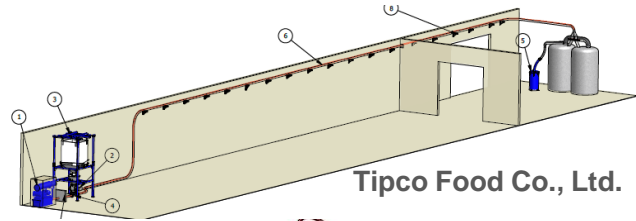

Tipco Food Co., Ltd.

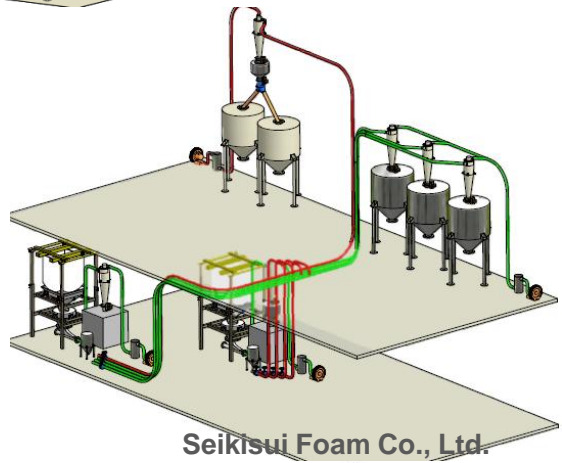

Seikisui Foam Co., Ltd.

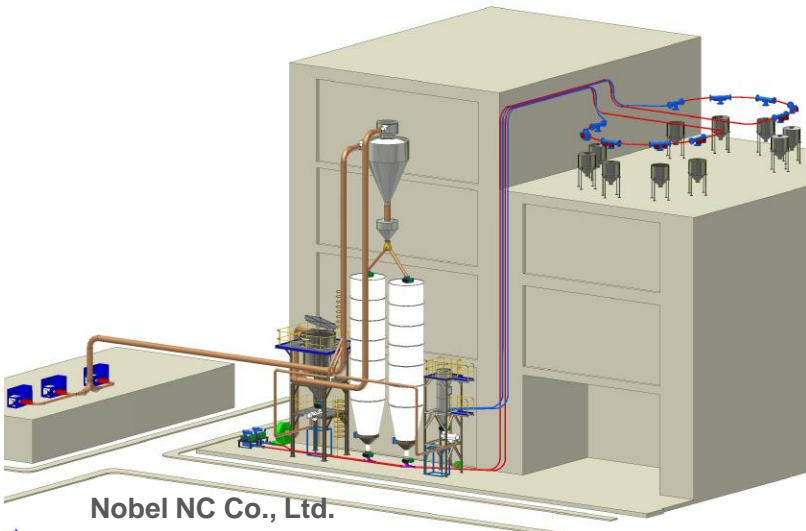

Nobel NC Co., Ltd.

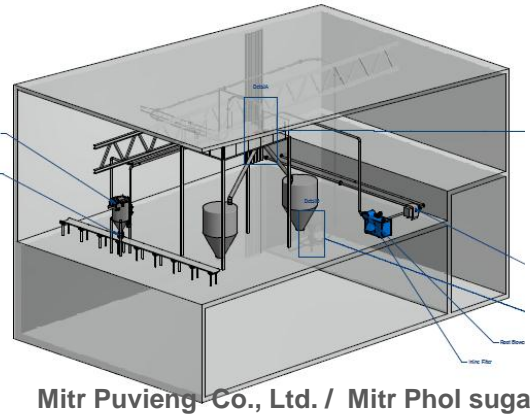

Mitr Puvient Co., Ltd. / Mitr Phol sugar

Theory and Design Pneumatic Conveying Systems

When we talk about pneumatic conveying systems, we must also be very much aware of what "mode" of conveying is taking place in the conveying line. Once again, we will discuss all the modes in more detail in future articles but below we have the basic descriptions of what each mode of conveying represents:

Dilute Phase, Loose phase, Lean phase

* Above the saltation velocity

- Typically less than 6 pounds solids per pound of air

Two Phase (mixed phase)

* Below saltation velocity

- 6 - 100 pounds of solids per pound of air

Dense Phase

- 20 - 500 pounds of solids per pound of air

* *Permeable piston*

- Special feed method required to form plugs

* *Non permeable*

- Special feed method required to form plugs

- Air assist, by-pass, etc. required to limit plug length

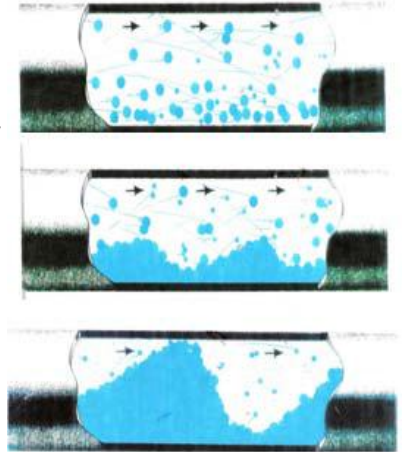

Top: Dilute Phase,
Middle: Two Phase,
Bottom: Dense Phase

While it may seem that all materials can be handled in any conveying phase, different material characteristics can limit the phases you can consider. To obtain a dependable conveying system, choose a conveying phase that's compatible with your material. Consider these material characteristics: particle size, material density, particle shape, moisture content, abrasiveness, and friability.

Beside of those physical properties that we have to consider, do not forget to consider the chemical property of the material which may can tell you about "*how sticky it will be in each possible condition of working process?*"

Please keep in mind that this is one of the most difficult characteristic which can only learn by the experiment and experiences and many times it is the major reason of the fail system!

Till now pneumatic conveying system design still be one of the very tricky engineering subject, it is (in the same time) both a stage of art and the engineering designing method.



The Various arrangement of The pneumatic conveying system

Calculation Program for System and Equipment

To be fast and precise, we have developed the calculation software program for pneumatic conveying system, and some other major equipment, combine with the software we have got from the oversea equipment that we are represent, it allow us to make the most suitable design for each of customer requirement.

Our own software development

THEREC CORPORATION LTD.
105/156 Moo.4 Karnjanapisek Rd., Bangbon, Bangkok 10150 Thailand.
Tel: (662) 8939003-4 Fax: (662) 8939005
E-mail: therec@truemail.co.th

Customer: _____
Contact: _____
Designed by: _____
Approved Date: _____
Material: _____

Ratio between products and the air
 $\mu = \frac{m_f}{m_p}$
 $\mu = \frac{1}{10^X} \left(\frac{VSF}{\sqrt{g \cdot D}} \right)^3$
 $X = 1.44C - 1.96$
 $Y = 1.15Z + 2.5$
 $VSF = 10^Y$ m/sec
 $V = 1.8 \cdot VSF = 10^Y$ m/sec

$Q = \frac{\pi D^2 v}{4}$ = 0 cu.m./sec
 $m_f = Q \rho_f$ = 0 cu.m./hr
 $m_p = \frac{m_c}{m_f}$ = NaN
 $v_c = v(1 - 0.008d^{0.3} \rho_f^{0.5})$ = 0 m/sec
 ρ_p = 0 kg./cu.m.

$\Delta P_c = \Delta P_1 + \Delta P_2 + \Delta P_3 + \Delta P_4$
 $\Delta P_1 = \rho_f \cdot v^2 \left(0.5 + \frac{\mu \cdot v_c}{v} \right)$ = NaN Pa
 $\Delta P_2 = \frac{\mu \cdot \rho_f \cdot g \cdot Z_v}{v_c}$ = NaN Pa
 Z_v Vertical Distance (m.) = 0
 $\Delta P_3 = \frac{\rho_f \cdot v^2 L (\lambda_f + \mu \lambda_c)}{2D}$
 $Re = \frac{D \cdot v \cdot \rho_f}{\eta}$ = NaN
 η Air Friction (Pa.sec) = 0
 $\lambda_f = \frac{0.316}{Re^{0.25}}$ = NaN
 $\lambda_c = \frac{64}{Re}$ = NaN
 $K = a \left(\frac{9.81 \rho_f (z_p - z_f)}{v^2} \right)^{0.3}$ = NaN
 $v_f = \begin{cases} \frac{0.155 g^{0.5} (z_p - z_f)^{0.5}}{2.3 \rho_f^{0.5}} & 3.5 \leq K < 45.6 \\ \sqrt{\frac{4 g (z_p - z_f)}{1.52 \rho_f}} & 45.6 \leq K < 23.60 \end{cases}$

$Fr = \frac{v^3}{gD} = NaN$
 $FrD = \frac{W_f}{gD} = NaN$
 $\lambda_1 = \begin{cases} \frac{2.1 \cdot Fr^{0.25}}{\mu^{0.3} \cdot Fr} \left(\frac{D}{d} \right)^{0.1} & ; D < 0.5 \\ \frac{0.082 \cdot Fr^{0.25}}{\mu^{0.3} \cdot Fr^{0.35}} \left(\frac{D}{d} \right)^{0.1} & ; D \geq 0.5 \end{cases}$
 $\lambda_2 = NaN$
 $\Delta P_4 = \frac{\rho_f \cdot v^2 L (\lambda_1 + \mu \lambda_2)}{2D}$ = NaN
 L Conveying distance (m.) = 0
 $\Delta P_5 = \frac{NB \rho_f v^2 (1 - \mu)}{2}$ = NaN Pa
 N Number of Bend = 0
 B Coefficient of Bend = 0
 $\Delta P_6 = \Delta P_1 + \Delta P_2 + \Delta P_3 + \Delta P_4 + \Delta P_5$ = NaN Pa
 Bag Filter Losses(Pa) = 0
 Cyclone Losses(Pa) = 0
 Inline Filter Losses(Pa) = 0
 Drop Box Losses(Pa) = 0
 Designed Pressure Losses = NaN (Pa)
 2.1E+9 Bar.G.

Pneumatic conveying system calculation page

THEREC CORPORATION LTD.
Project Detail
Customer: _____ Material: _____
Contact: _____ 03/10/2559

Designed Air Flow Rate
Quantity: _____ kg/hr
_____ lbs/hr
_____ lbs/min
Bulk Density: _____ kg/m3
_____ lbs/cu.ft
Feeding Volume: _____ m3/hr
_____ cu.ft/hr
Flying Velocity: _____ ft/min
_____ m/s
Ratio: _____
Required Flow: _____ m3/hr
_____ cfm
Designed Flow: _____ cfm

Pipe Sizing
Stage1
Pipe Size: _____ inches EQL 90 = _____
Air Velocity: _____ ft/min.
Margin: _____ %
Stage 2
Pipe Size: _____ inches EQL 90 = _____
Air Velocity: _____ ft/min.
Margin: _____ %
Stage 3
Pipe Size: _____ inches EQL 90 = _____
Air Velocity: _____ ft/min.
Margin: _____ %

Pipe Loss
Stage 1 Loss per Feet _____ Inch.Aq.
Horizontal _____ ft Vertical _____ ft
Elbow 45 _____ unit Elbow 90 _____ unit
Total Loss _____ Inch.Aq.
Stage 2 Loss per Feet _____ Inch.Aq.
Horizontal _____ ft Vertical _____ ft
Elbow 45 _____ unit Elbow 90 _____ unit
Total Loss _____ Inch.Aq.
Stage 3 Loss per Feet _____ Inch.Aq.
Horizontal _____ ft Vertical _____ ft
Elbow 45 _____ unit Elbow 90 _____ unit
Total Loss _____ Inch.Aq.

Equipment Loss
Cyclone
Bag Filter
Inline Filter
Ejector
Drop Out Box
Suction Nozzle

Total Head Loss in System
Summation of Loss _____ 0 Inch.Aq.
Safety Factor _____ %
Designed Head Loss _____ Inch.Aq.
_____ mm.Aq.
_____ mBar
_____ PSI

Cleaning system design
This software is made by Therec Corporation Ltd.
The software is used for the design of pneumatic conveying system.
The software is made by Therec Corporation Ltd.
The pneumatic conveying system design
The software is made by Therec Corporation Ltd.

Define
Air Filter Rate = _____ CMM
Volumetric Flow rate = _____ CMM
Total Flow = 1687 CMM
Diameter of filter bag = _____ mm.
Length of filter bag = _____ mm.
Pressure = _____ bar.

Blind flange filter area required
Total filter area = 222 m2

Number of filter bag required
Area per one filter bag = 0.24 m2
Amount of filter bag = 24 bags

Volume required
Flow rate across bag = 1686 L/s
With support = 2226 L/s
Jagged valve size = _____
No. of bag per valve = 20 bags/valve
Number of valve = 2 valves

Horizontal diameter required
Horizontal hole diameter = 6 mm.

Distance between nozzle to bag
Distance = 148.6 mm.

Diameter of header required
Diameter of header = 4 inch

Therec Corporation Ltd.
105 / 156 Moo 4, Bangbon, Bangbon, Bangkok 10150 Thailand
Tel: +662 893-9003 - 4 (5 Lines Auto) Fax: +662 893-9005
http://www.therec-corp.com E-mail Address: therec@truemail.co.th sales@therec-corp.com

Air & Gas handling head loss calculation program

Bag Filter calculation program

$$\Delta P_{(Hoz)} = \frac{V_g^2 \cdot \rho_g}{2 \cdot g} + \frac{W \cdot V_p}{g} + \frac{2 \cdot f \cdot \rho_g \cdot V_g^2 \cdot L}{g \cdot D} \cdot \left(1 + \frac{f_p \cdot V_p}{f \cdot V_g} \cdot \frac{W}{V_g \cdot \rho_g} \right)$$

Pneumatic conveying calculation formula

Basic Machine & Component to perform Pneumatic conveying

Actually there are only few machine and component required to make a pneumatic conveying system / minimum are only three main portion **Feeder** ,**Shooter** and **Receiver**

Feeder / Sample / Bulk bag unloading Station, Hopper & Rotary valve

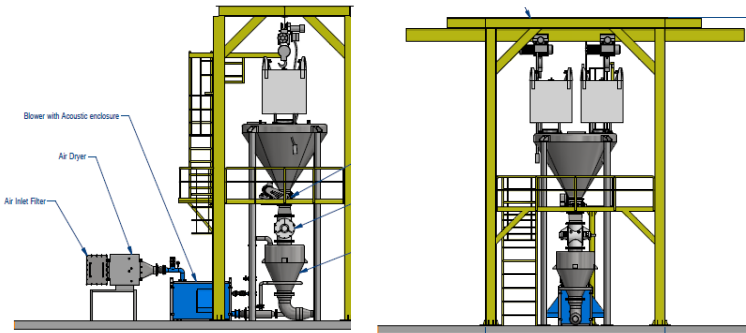

Shooter / Sample / Roots blower package set with Air filter, Air dryer, Air cooler and Chiller set

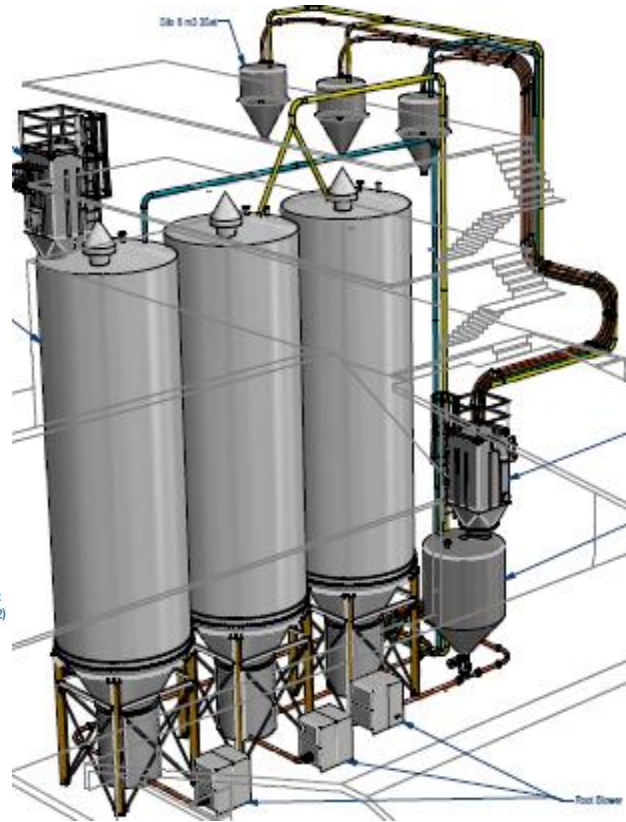
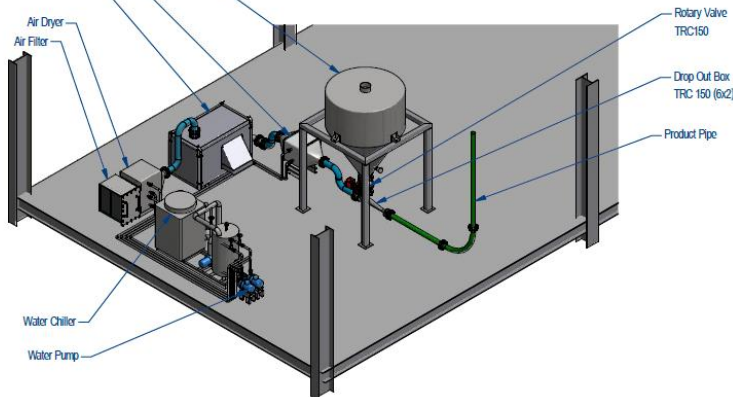

Receiver / Sample / Cyclone , Bag filter and Silos

Fourteen Steps of pneumatic conveying system building

If you are going to be the good system designer we should going deep into the design and built of the system you may like to follow these 14 steps as ours.

1. Material evaluation, Testing & Checking
2. Capacity & Operation method
3. Piping & Routing
4. Area of Installation
5. System clarification & Test
6. Main equipment choosing
7. Pneumatic Conveying System design
8. Engineering Diagram and Drawing
9. The 4 main equipment design
10. Project clarification
11. Production and or installation
12. Commissioning
13. Documentation and report
14. Service and Maintenance

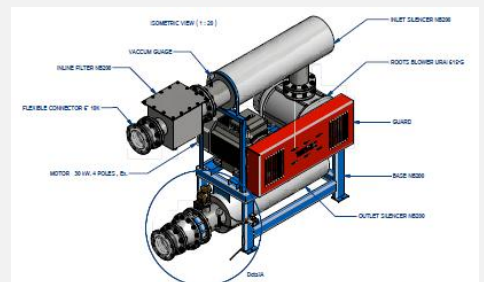

Requirement Evaluation Steps
System design Steps
Operation Steps

The Right Blower for Your Pneumatic Conveying System

Blower Specification
Motor Power 20 HP , Speed 2950 rpm

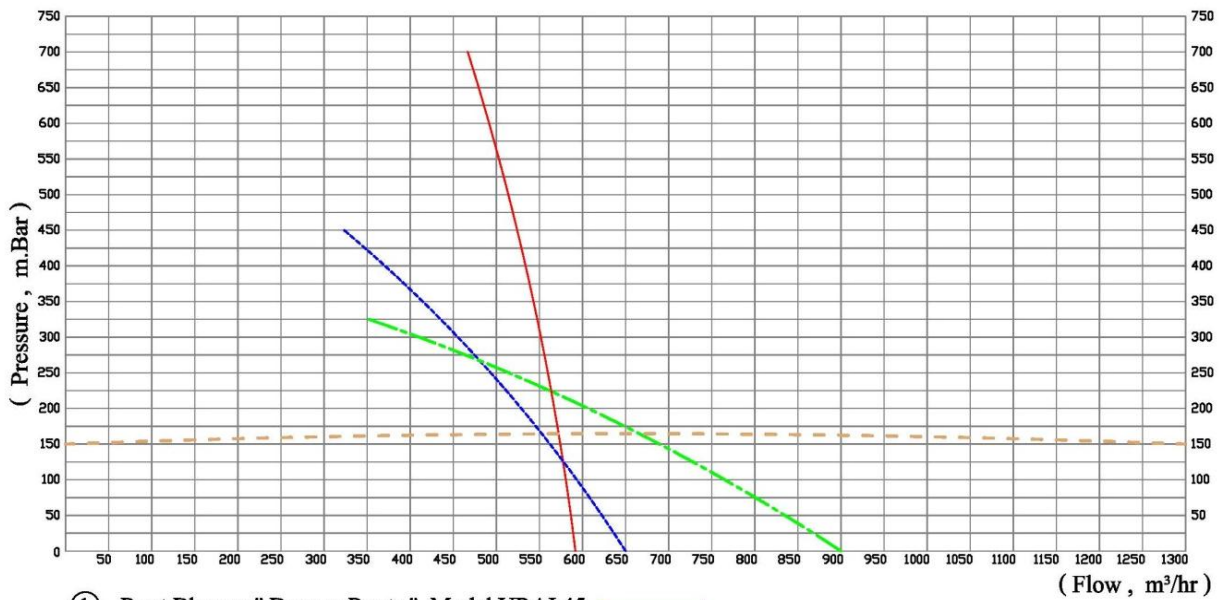

- ① Root Blower " Dresser Roots " Model URAI 45 ————
- ② Super High Pressure Double stage impeller Ring Blower " FPZ " Model SCLK 09TD ————
- ③ High pressure Single impeller Ring Blower " FPZ " Model (SCLK 11 MS) ————
- ④ High Pressure Multi stage Centrifugal Blower " SAV10 " Model MI-CO 160/4 ————

Size of the blower (or exhauster) is up to the size of the system , we need to choose the right blower with suitable flow and pressure but:

First of all ,we have to understand the truly need of our specific system and must not forget to choose the most suitable type of blower for each pattern of the system.

Cost is the very important reason of all time/ different type of blower cause the different prices/ but please remember that with the wrong type of blower you will not be able to make it operate properly and it would also cause you a lot of waste in material ,time and labour / and finally again cost!

Above graph is made by our sister company **THEREC CORPORATION LTD.** Who have the long time experience in selling the high pressure blowers for more than 18 years, it show the comparison between three major types of high pressure blower

Centrifugal blower will give you the relatively constant pressure with variable flow. Roots blower will give you the very fixed flow at variable pressure. While the ring blower will give you the mixed of that two characteristic

Finally ,please also being informed that the different type of blower would need the different type of electrical circuit **control**.



Our oversea supplier calculation software

File Windows Help

Make New Selection

Change Old Selection

Unit Performance

Set Default Values

Inlet / Discharge Losses

Manufacturing Locations

Web Update

Exit Program

OPEN Loop
(system pressure = barometer)
Inlet Loss: 15 mbar
Disch. Loss: 15 mbar
<<CLICK HERE TO ADJUST>>

Blower System

Pressure

Vacuum

Unit Type

AIR Unit

GAS Unit

STEAM Unit

Release Date 31/03/2004 Version 1.4 **Blower Selection Program** *Continue*

GE Roots blower calculation page

Savio s.r.l. Blower Selection Rel. 1.1 of 11/07/2019

File Options Run ?

- Units
- Conditions
- Preferences
- choose Language
- Choose Output Language

SAVIO Srl
TECNOLOGIA DELL'ARIA

Click "Options" and select your preference

Savio s.r.l. - Via Reggio Calabria, 23 - 10095 Caselle Via-Rivol (TO) - ITALIA - Tel: +39 011 939 18 81 (5L. Aut.) - Fax: +39 011 939 28 63

Savio Multistage Centrifugal calculation page

Rotary Valve in Pneumatic Conveying System

Rotary valve is one of the three major equipment in dilute phase pneumatic conveying system (together with blower and bag filter or cyclone). Many people may think that the rotary air lock valve in pneumatic conveying system is the same valve as the feeding valve in powder feeding process or the same valve as what we saw under the bag filter in normal dust collecting system.

In fact it is not true, we would like to confirm you that it is totally different;

-While the feeding and dust collecting rotary valve has 0.5-1.0 mm clearance, the good pneumatic conveying valve will only have around 0.13-0.15 mm clearance.

-Rubber blade may be the good choice of the dust collecting valve but it is nearly prohibited to be used for pneumatic conveying valve because of the very fast wear and poor resistance to the high pressure and deep vacuum.

-Feeding and dust collecting valve may have 1 single shaft lip seal but the good valve for pneumatic conveying may have 3 lip seals of each side of the shaft with gland packing and air purge seal.

-The feeding or dust collecting valve may have only one series with one type of rotor but the pneumatic conveying valve can have 5 series to be matched with many types of system and 8 types of rotor to be matched with many types of material.

-The feeding or dust collecting valve only have inboard bearing version but we surely need to use the outboard bearing version of pneumatic conveying rotary valve (with air purge seal and breathing plug) in case of the high pressure powder material transferring system.

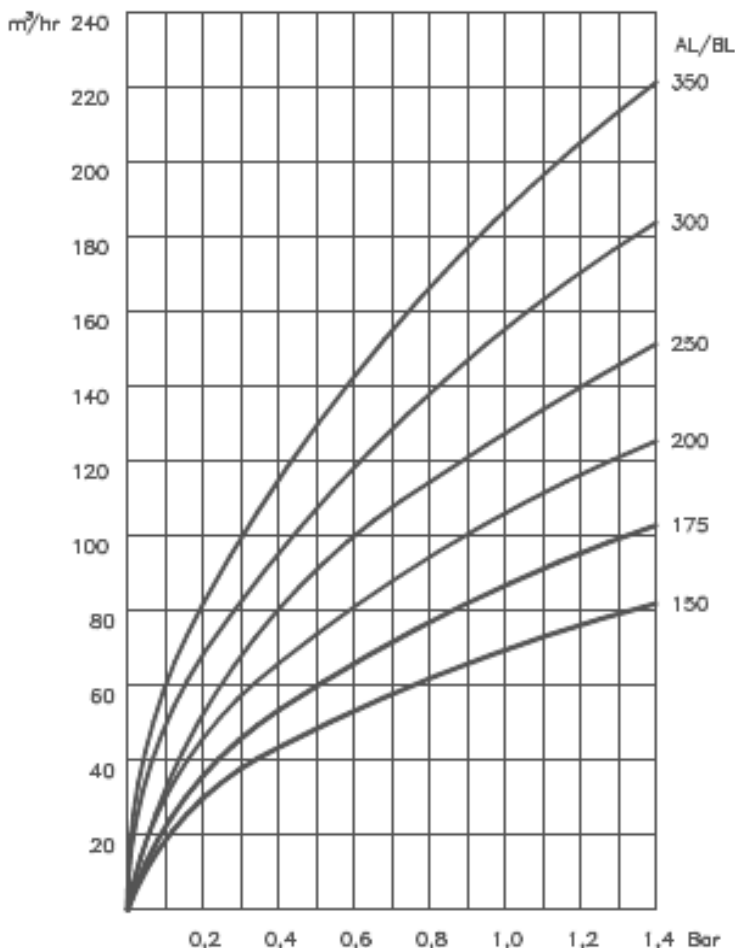

This air leakage graph is coming from DMN Westinghouse manual, based on 0.13 mm clearance, the air lost of each size is as per the graph. Please be careful that in case of poor quality, big clearance, valve and high pressure or deep vacuum system you may even lose 50% of the air that your blower produces by this leakage.

If this situation happens, it would be very sure that your pipe line will all be blocked and come later with the very hard work in clearing it along.

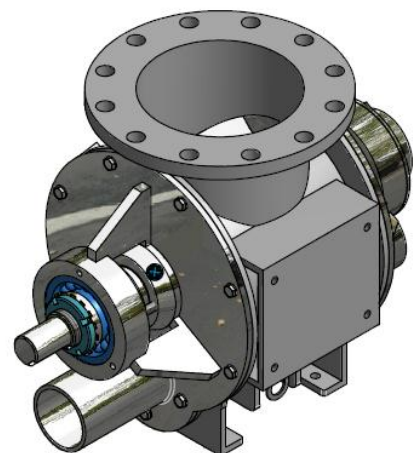

Dust Collecting Equipment in Pneumatic Conveying System

Even pneumatic conveying system is very well known as the most cleanliness way of conveying but still one of the very popular problem in all pneumatic conveying system is air leakage and dust pollution which always occur and need to be properly control

Most of the time we would need the dust collecting equipment which can be some time “cyclone” and many times “bag filter”. These equipment is look very common and need not very high technology support but still have some thing need to be careful

For Cyclone,

- We mostly need the high efficiency cyclone to trap all the dust inside but for plastic pellet it is not the good idea at all. I never see any one want to have the dust in their martial. It will create you a lot of problem in injection process so in plastic pellet cases we would need the low efficiency one.
- For food industries ,do not forget to prepare the very smooth inside surface and make it in the hygienic ,food grade way. Also 100% prepare the port and equipment that allow the end user to do CIP process after use it.

For Bag filter,

- Please always keep in mind that “simply is the best” compact filter can give you the smaller total dimension, lower fabrication cost for smaller housing, use less jet cleaning air, save the energy but for the sticky material and the material which is sensitive to the moisture it may be the better idea to pay a little bit more price and use a bit bigger installation area. Do not forget that Thailand is in the tropical zone and some month of the year our relative humidity is nearly 100%. I can confirm by long time experience that it easily can cause you the nightmare cleaning job.
- Do not use rectangular shape bag filter with Roots blower it will break your bag filter very soon after first first minute in test run process. Round shape is the best. Even the steel rod you use in the filter insert case also need to be 2 times thicker when cam pare to the system that use the ordinary centrifugal blower.
- For some material like sugar , I think if not so tropism please do not use bag filter. Waste scrubber may be the better idea, especially in the process that loading sugar to the syrup mixing tank ,with hot water. As far as we can remember the cleaning cycle time of bag filter for sugar powder is always a lot shorter when compare to other easier product.

For In-line filter,

- It is always the very good idea to put in-line filter in all of the vacuum system even you already have the main bag filter installed in the system. It is because of ,after many time of cleaning process there is the very high risk that the operation do not put the bag back into the casing properly and a lot of dust can go inside the blowers.
- Clearance in Ring and Roots blower is mostly les than 0.5 mm and many times even the normal 80 gram paper still cannot be pushed to pass these small clearance zone and hard particle can easily make these expensive high pressure exhauster to be damage.



Turn-key project of Bulk material handling system

-Process design for **Plastic Industry**

-Material handling along through the process line



Picture from the existing line of Twin Lion PVC Pipe factory

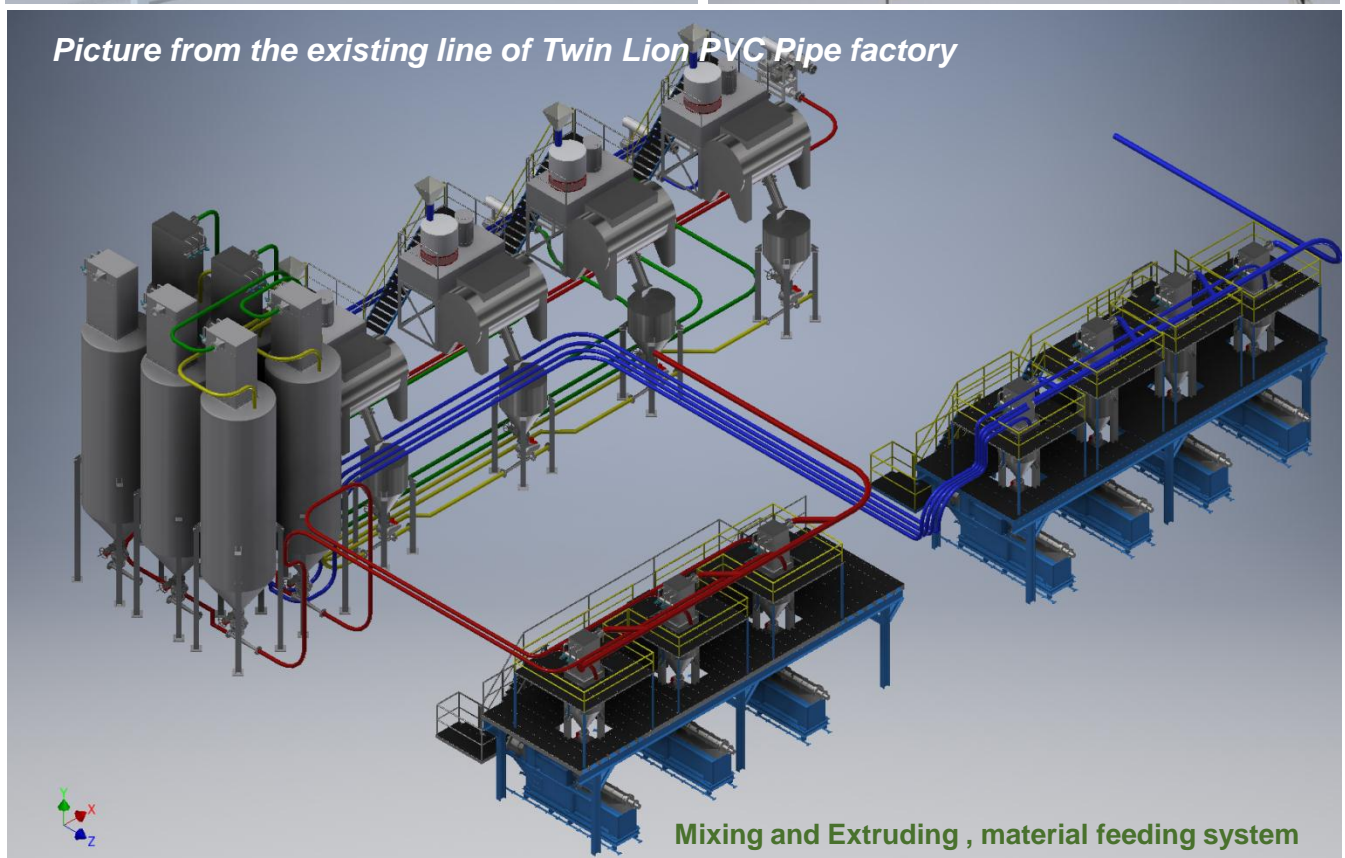

THEREC ENGINEERING & CONSULTING CO.,LTD.

THEREC PROCESSING MACHINE CO.,LTD



Big Bag Filling & Unloading Station

High Pressure Blower

Bulk Material Handling Machine & Accessories

Vacuum pump

Small bag & Tote Bin Dumping Station

Material handling fan & blower

Size reduction and classification machine

Dust explosion control equipment

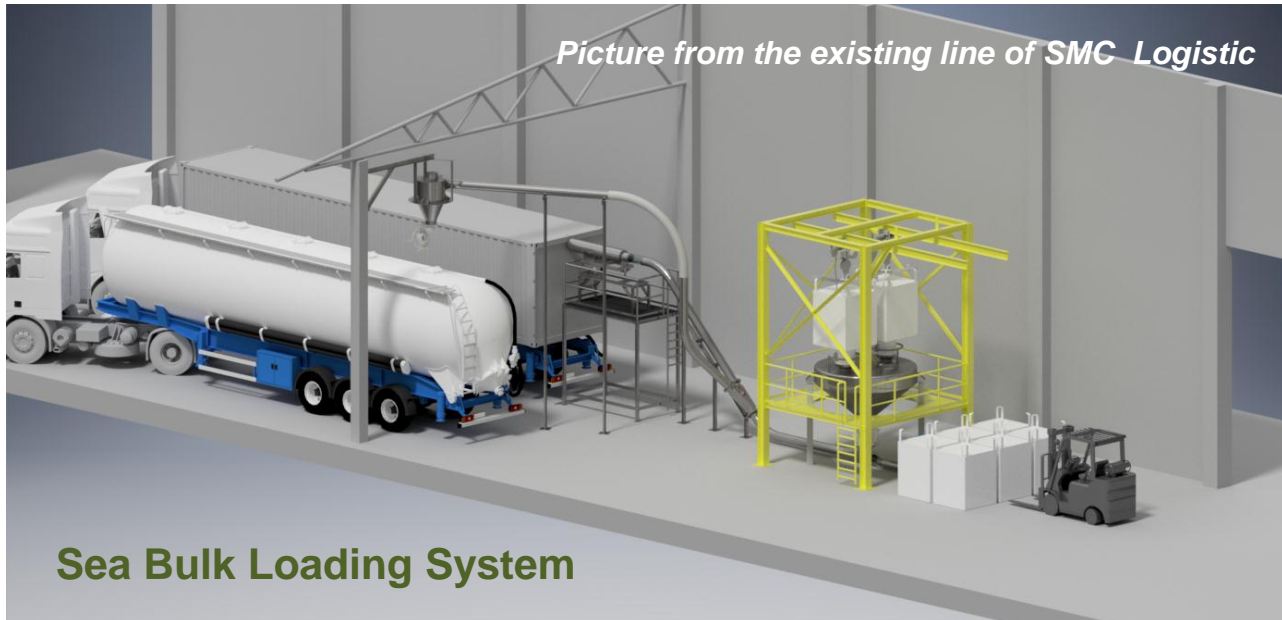

Picture from the existing line of SMC Logistic

Sea Bulk Loading System



Rotary & Diverter Valve

Stainless Steel Hopper & Silo

Lump Breaker / Lump Crusher

Stainless Steel Cyclone & Receiver

Food Grade Screw Conveyor

Stainless Fabrication Work

Therec Engineering & Consulting Co, Ltd. www.thereceng.com

Tel (662) 893 9003-4 (5 lines)

Fax : (662) 893 9005 ,893 9178

88 Soi Karnjanapisek 4/2 Karnjanapisek Rd. Bangbon Bangkok 10150 Thailand

General product Therec 01 / 2016

